

Indoor Unit Operation & Installation Manual

AWSI-EAV012-N11

No.0150510088

- Please read this manual carefully before using
- Keep this operation manual for future reference



Большая библиотека технической документации

<https://splitsystema48.ru/instrukcii-po-ekspluatacii-kondicionerov.html>

каталоги, инструкции, сервисные мануалы, схемы.

User Manual

The indoor unit, suspended to ceiling or standing on floor, renders considerable operating ease and flexibility.

With its ultra-thin design, dazzling exterior and space economy, the indoor unit fits in well with indoor scenarios.

Boasting superb power and fast temperature tuning, the indoor unit delivers undeniable comforts and pleasures whenever you feel like wanting the same.

Highly efficient silencing technology greatly reduces operating noises and delivers natural comforts.

In case of sudden blackout during operation, the indoor unit, with its Blackout Retrieval function preset, is capable of retrieving its operating status prior to the blackout when power supply is restored.

Integrated Control is available with the indoor unit (through integrated controller).

Multi-connected unit series features “uniform control mode”, i.e., all indoor units are restricted to run on heating or cooling mode at the same time.

For the protection of compressor, the air conditioning unit shall be powered for over 12 hours.

Contents

Parts and Functions	1-3
Safety Considerations	4-6
Operation instruction	7-10
Operation hints	11-12
Maintenance	13
Fault Checkup	14
Installation Procedures	15-17
Electrical Wiring	18-20
Test Run & Fault Code	21-22
Disposal	23

whole model	brief model
AWSI-EAV012-N11	EAV012

The brief model is used in this manual for above models.

Operating Range of Air Conditioner

cooling dry	indoor	max.	DB: 32°C	WB: 23°C
		min.	DB: 18°C	WB: 14°C
	outdoor	max.	DB: 43°C	WB: 26°C
		min.	DB: -5°C	
heating	indoor	max.	DB: 27°C	
		min.	DB: 15°C	
	outdoor	max.	DB: 21°C	WB: 15.5°C
		min.	DB: -15°C	

Parts and Functions

Indoor unit

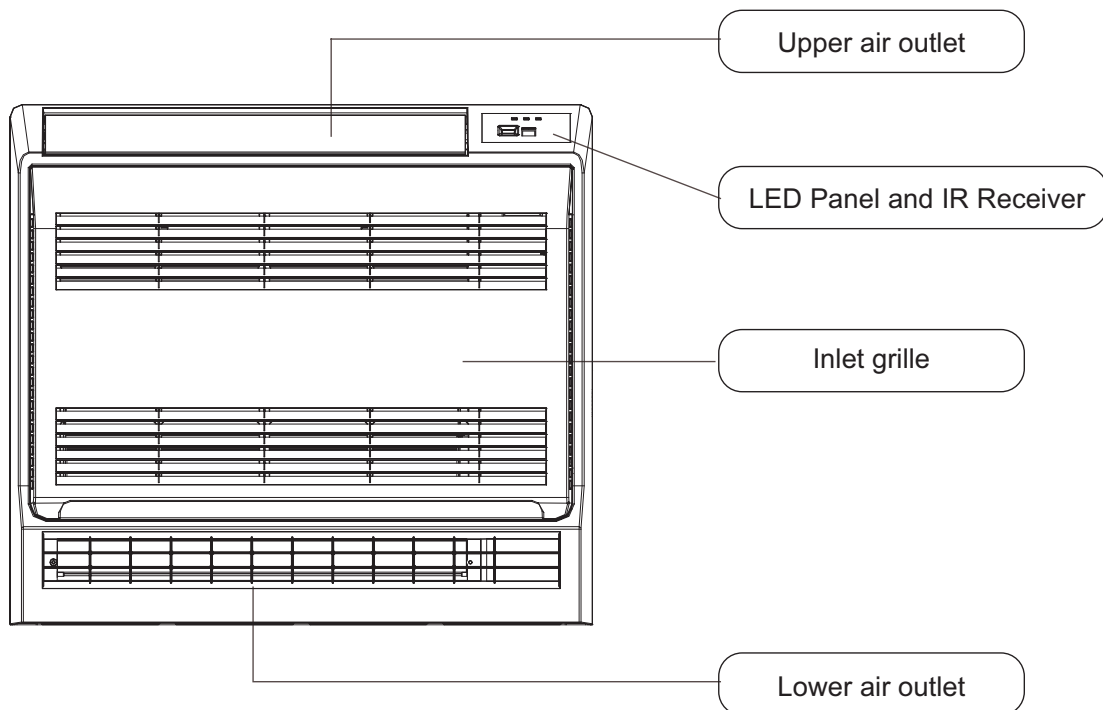

LAMPS ON INDOOR UNIT

LED panel and IR Receiver

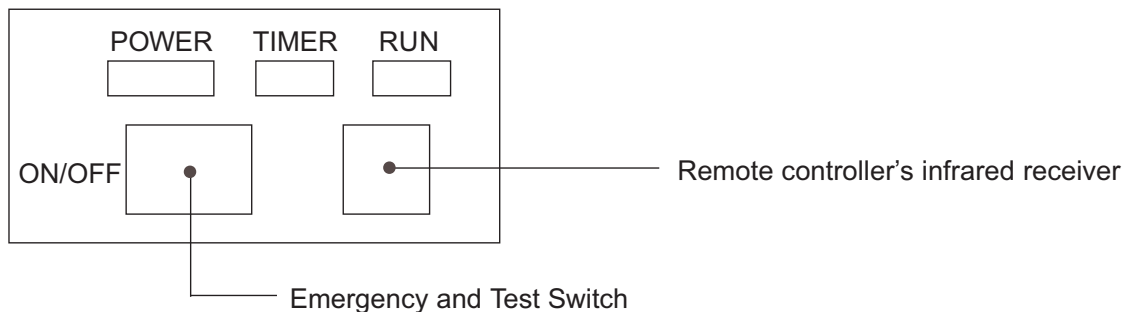

“POWER” lamp

It lights up when the Indoor Unit is powered.

“TIMER” lamp

It lights up when “TIMER” function is activated for programmed start/stop.

The timer lamp flashing when the unit have some malfunction happens, flashing times stands for corresponding number, detailed information see the malfunction sheet.

“RUN” lamp

It lights up when the compressor (Outdoor Unit) is operating.

Parts and Functions

Remote controller

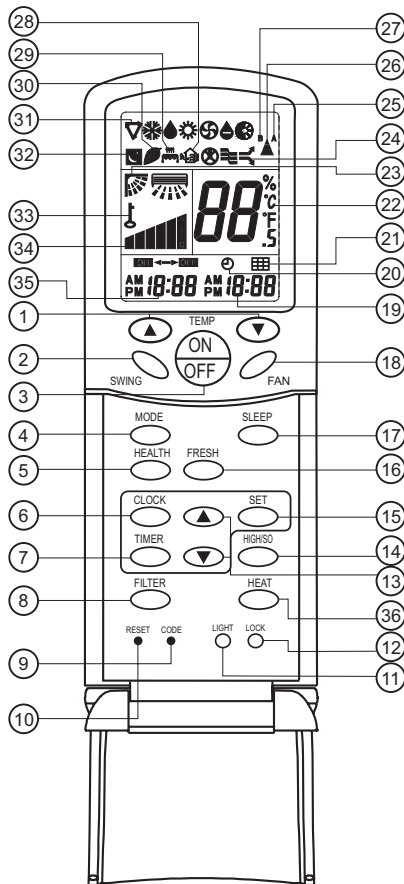

1.TEMP Setting Button

Used to set temperature.

The temperature ranges: 16°C~ 30°C.

In Up/Down function of filter, for controlling up and down filter.

2.SWING Button

If you press this button once, auto swing will be activated. If you press this button again, the louver will fix in the present position.

3.Power ON/OFF Button

Used for unit to start or stop.

After power on, the LCD of remote controller will display the previous operation state (except for TIMER,SLEEP and SWING state).

4.Operation MODE Button

Used to select operation mode.

Every time you press MODE button, operation mode changes according to following sequence:

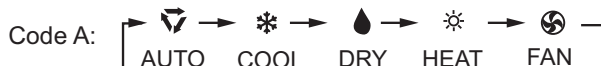

5.HEALTH Button

Used to set health operation function.

6.CLOCK Button

Used to set correct time.

7.TIMER Button

Used to select TIMER mode:TIMER ON,TIMER OFF, TIMER ON-OFF.

(Note: if the time of TIMER ON is the same as TIMER OFF, TIMER ON-OFF cannot be set)

8. FILTER Button

Used to set up/down function of filter.

9.CODE Button

Used to select Code A or B, Normally at Code A. As you can't control the indoor unit, please change the Code to B.

10.RESET Button

Press this button by using a sharp article to resume the correct operation of the remote controller in case of need, for example, in case of malfunctions due to electromagnetic disturbance.

11.LIGHT Button

Used to light the control panel

12.LOCK Button

Used to lock operation button and LCD display contents. If you press this button, the other buttons come out of function and lock state display appears; if you press it again, lock state will be no more active and lock state display will disappear.

13.HOUR Adjustment Button

Used to set clock and timer setting

14.HIGH/SO Button

Used to select HIGH or SOFT operation.

15.SET Button

Used to confirm TIMER and CLOCK settings.

16.FRESH Button

Used to set fresh mode, the unit will draw in fresh air.

17.SLEEP Button

Used to set sleep mode. (The clock must be corrected before setting sleep function)

18.FAN Button

Used to select fan speed:LOW,MID,HIGH,AUTO.

19.TIME Display

20.TIMER Display

21.FILTER Display

When the filter need be cleaned, you can press the FILTER button for 3s, to up/down function.

22.TEMPERATURE Display

23.AUTO SWING Display

Parts and Functions

24.HIGN/SO Run Display

25.Code A of controller's state

Code A is used for the units in this manual.

26.SIGNAL SENDING Display

27.Code B of controller's state

28.Fresh Display

29.Auxiliary ELECTRICAL HEATING Display

30.HEALTH Display

Displays when healthy run function is set.

31.Operation MODE Display

AUTO RUN	COOL RUN	DRY RUN	HEAT RUN	FAN RUN
▽	☼	💧	☀	⚙

32.SLEEP State Display

33.LOCK State Display

34.FAN SPEED Display



35.TIMER ON Display

36.HEAT Button

Used to select auxiliary heater function.

Note:

1.Models in this manual have no functions

⑤ ⑧ ⑪ ⑭ ⑯ ⑰ ⑳ ㉔ ㉕ ㉖ ㉗ ㉘ ㉙ ㉚ ㉛

2.HIGH/SO button

This button is active in Cooling/Heating mode, the fan speed is in AUTO mode after pressing it and "high function" will be automatically cancelled after 15 minutes running.

Remote Controller Operation

- When in use, direct signal transmission head to the receiver placed on the indoor unit.
- The distance between the remote controller and the receiver should be max 7m and there should be no obstacle between them.
- Do not throw the remote controller to prevent it from being damaged.

- When operating the remote controller in an area where electronically controlled lights are installed or wireless handsets are used, please move closer to the indoor unit as the function of the remote controller might be affected by signals emitted by the above mentioned equipments.



Battery loading

Batteries are fitted as follows:

Remove the battery compartment lid

Slightly press and disengage the battery compartment lid marked with "▽" and then hold the remote controller by the upper section and then remove the battery compartment lid by pressing in the direction of the arrow as shown in the figure above.

Loading the battery

Ensure that batteries are correctly placed in the compartment as required for positive and negative terminals.

Replacing the battery compartment lid

The battery compartment lid is reinstalled in the reverse sequence.

Display review

Press the button to see if batteries are properly fitted. If no display appears, refit the batteries.

Confirming indicator

If no indication is displayed after press ON/OFF button, reload the batteries.

Caution: if the remote controller does not operate as designed after fitting new batteries of the same type, press the Reset button (marked ↓) with a pointed article.

Note:

It is recommended that the batteries should be removed from the compartment if the remote controller is not used for an extended period.

The remote controller is programmed for automatic test of operation mode after the batteries are replaced. When the test is conducted, all icons will appear on the screen and then disappear if the batteries are properly fitted. When throw away the waste batteries, please perform in accordance with the local regulation.

Clock Set



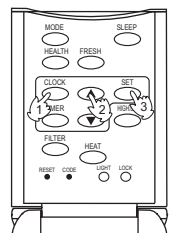

When the unit is started for the first time or after replacing batteries in remote controller, clock should be adjusted as follows:

- 1.Press CLOCK button, clock indication of " AM " or " PM " flashes.
- 2.Press " ▲ " or " ▼ " to set correct time. Each press the time will increase or decrease by 1 min. If the button is kept pressed, the time will increase or decrease quickly.
- 3.Press "SET" button to confirm the time setting. AM or PM stop flashing, while clock starts working.

Note:AM means morning and PM means afternoon.



Safety Considerations

- If the air conditioner is transferred to a new user, this manual shall be transferred to the user, together with the conditioner.
- Before installation, be sure to read Safety Considerations in this manual for proper installation.
- The safety considerations stated below is divided into “ Warning” and “ Attention”. The matters on severe accidents caused from wrong installation, which is likely to lead to death or serious injury, are listed in “ Warning”. However, the matters listed in “ Attention” are also likely cause the severe accidents. In general, both of them are the important items related to the security, which should be strictly abided by.
- After the installation, perform test run to make sure everything is in normal conditions, and then operate and maintain the air conditioner in accordance with the User Manual. The User Manual should be delivered to the user for proper keeping.



Warning

- Please ask the special maintenance station for installation and repair. Water leakage, electric shocks or fire accidents might be caused from improper installation if you conduct the installation by your own.
- The installation should be conducted properly according to this manual. Water leakage, electric shocks or fire accidents might be caused from improper installation.
Please make sure to install the air conditioner on the place where can bear the weight of the air conditioner.
- The air conditioner can't be installed on the grids such as the non-special metal burglar-proof net. The place with insufficient support strength might cause the dropdown of the machine, which may lead to personal injuries.
- The installation should be ensured against typhoons and earthquakes, etc. The installation uncomformable to the requirements will lead to accidents due to the turnover of the machine.
- Specific cables should be used for reliable connections of the wirings. Please fix the terminal connections reliably to avoid the outside force applied on the cables from being impressed on the cables. Improper connections and fixings might lead to such accidents as heating or fire accidents.
- Correct shapes of wirings should be kept while the embossed shape is not allowed. The wirings should be reliably connected to avoid the cover and the plate of the electrical cabinet lipping the wiring. Improper installation might cause such accidents as heating or fire accidents.
- While placing or reinstalling the air conditioner, except the specific refrigerant (R410A), don't let the air go into the refrigeration cycle system. The air in the refrigeration cycle system might lead to the cracking or personal injuries due to abnormal high pressure of the refrigeration cycle system.
- During installation, please use the accompanied spare parts or specific parts. If not, water leakage, electric shocks, fire accidents or refrigerant leakage might be caused.
- Don't drain the water from the drainpipe to the waterspout where may exist harmful gases such as sulfureted gas to avoid the harmful gases entering into the room.
- During installation, if refrigerant leakage occurs, ventilation measures should be taken, for the refrigerant gas might generate harmful gases upon contacting the flame.
- After installation, check if any refrigerant leakage exists. If the refrigerant gas leaks in the room, such things as air blowing heaters and stoves, etc. may generate harmful gases.
- Don't install the air conditioner at the places where the flammable gases may leak. In case the gas leakage occurs around the machine, such accidents as fire disasters may be caused.
- The drainpipe should be properly mounted according to this manual as to ensure the smooth drainage. In addition, heat preservation should be taken to avoid condensation. Improper drainpipe mounting might cause water leakage, which will get the articles at home wet.
- The refrigerant gas pipe and liquid pipe should be heat insulated to preserve heat. For inappropriate heat insulation, the water caused from the condensation will drop to get the article at home wet.

Attention

- The air conditioner should be effectively grounded. Electric shocks may occur if the air conditioner is ungrounded or inappropriately grounded. The wire for earthing shouldn't be connected to the connections on the gas pipe, water pipe, lightning rod or telephone.
- The breaker for electricity leakage should be mounted. If not, accidents such as electric shocks may happen.
- The installed air conditioner should be checked for electricity leakage by being powered.
- If the ambient humidity bigger than 80%, when the water discharge hole be blocked or the filter becomes dirty, or airflow speed change, there maybe leads to condensing water drop down, and at the same time there maybe some drops of water spit out.

Safety Considerations

	Items with this warning sign concerning the product's safety and the personal security must be performed strictly.
	Items with this forbidding sign refer to absolutely forbidden behaviors. If not, they may cause machine damage or endanger operator's personal safety.

Clean the filter regularly.
Cooling or heating performance will be degraded if the filter is blocked, resulting in large power consumption, failure, and water dripping at freezing.

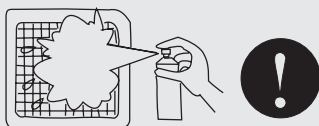

Don't touch the outlet while the flap is moving. Don't put anything in the grid in case danger may occur.

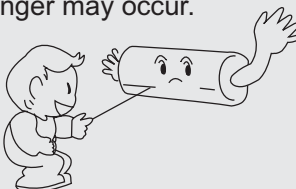

Avoid cold wind from blowing out.
During heating running, the fan of indoor units will not rotate immediately as to prevent cold wind from blowing out.

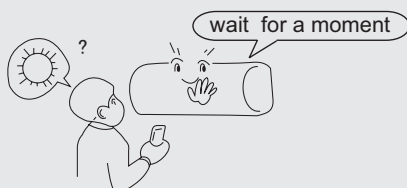

Changing Wind Speeds:
In the state of refrigerating, with automatic blowing mode, the wind speed automatically decreases when the room temperature approaches the setting.
In the state of heating, when the room temperature reaches the setting temperature the compressor stops working and the fan turns to low wind or stops. Wind speed changes automatically in the dehumidifying mode.

Regulating Wind Direction:
It is recommended not to make the wind deflector downwards for a long time to avoid condensation at air outlet port during refrigerating or dehumidifying.
Water dropping might appear at the air outlet port in refrigerating or dehumidifying mode.

Defrosting:
During heating running, the air conditioner would defrost automatically if there is frost on heat exchanger of outdoor units.
Do not rotate fans of both indoor units and outdoor units during defrosting.
After finishing defrosting, the air conditioner will resume running automatically.

The machine operation must be controlled by the control.





















Hints:
As air conditioners absorb heat from the environment and release it to the room, heating effects will be influenced by the temperature in and out of the room.

Safety Considerations



Attention

Notices during Operation

- It is not allowed to put any heating apparatus under the indoor units, for the heat may cause distortion of the units.
- Pay attention to the aeration condition to avoid anoxic symptom.  
- Flammable apparatus should not be placed in the place where the air conditioner wind could reach directly, or incomplete burning of the apparatus may be caused.  
- Check the mount table of the air conditioner for damage for a long period of operation. If placed on the damaged table, the unit may drop down causing damage. 
- Plants and animals should not be put to the place where wind of the air conditioner blows directly, otherwise damage to them may be caused. 
- It cannot be used for the preservation of food, living creature, precise instrument and artworks, etc, otherwise damage may occur. 
- Use the fuse with proper capacity. Metal wires and copper wires, etc., may cause fire or other faults. 
- Do not use water heater or like next to the indoor unit and the wired controller. Water/power leakage or short circuit may happen if the steam generating apparatus is working next to machine. 
- Defrosting during heating
To improve the heating effect, the outdoor unit will perform defrosting automatically when frost appears on the outdoor unit during heating (approximately 2-10 min). During defrosting, the fan of the indoor unit runs at a low speed or stops while that of the outdoor unit stops running. 
- Power should be cut off when the air conditioner is left unused for a long period. Power will be consumed if the air conditioner is not powered off. The power switch of the outdoor unit switch should be powered on 12 hours in advance before operation to protect the unit after a long period of storage. 
- 3-minute protection
To protect the unit, compressor can be actuated with at least 3-minute delay after stopping.
- Close the window to avoid outdoor air getting in. Curtains or window shutters can be put down to avoid the sunshine. 
- Do not touch the switch with the wet hand to avoid power shock. 
- Stop running and switch off the manual power switch when cleaning the unit. 
- During the operation of the control unit, don't switch off the manual power switch and the controller can be used. Please do not press the liquid crystal zone of controller to prevent damage. 
- Cleaning the unit with water may cause electric shock.  
- Do not put flammable spray close to the air conditioner. Don't inject flammable spray towards the air conditioner, which may cause fire. 
- Stopping fan rotation
The unit which stops operating will actuate the fan for a 2-8 min swing every 30-60 minutes for protecting the unit while other indoor unit are in the operating state.
- This appliance is not intended for use by persons (including children) with reduced physical, sensory or mental capabilities, or lack of experience and knowledge, unless they have been given supervision or instruction concerning use of the appliance by a person responsible for their safety.
- Children should be supervised to ensure that they do not play with the appliance.

Operation instruction

AUTO, COOL , HEAT and DRY Operation

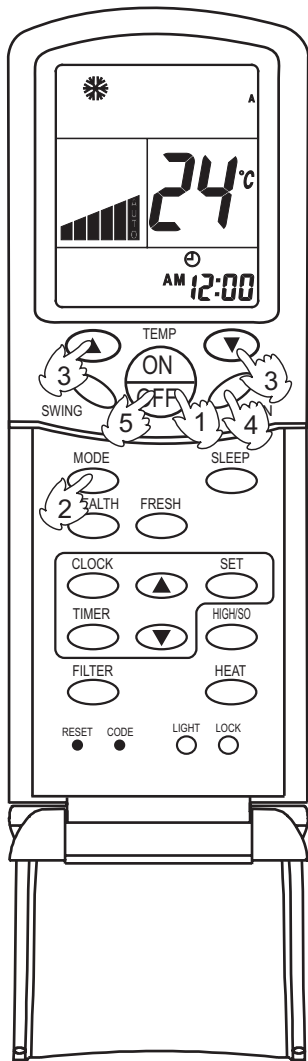

(1) Unit start

Press ON/OFF button, the unit starts.

Previous operation status appears on LCD (except for TIMER, SLEEP and SWING setting)

(2) Select operation mode

Press MODE button. Each press, the operation mode changes as follows:

Code A



Then select AUTO, COOL, DRY or HEAT as needed.

(3) Temperature setting

Press TEMP button.

▲ Every time the button is pressed, the setting temperature increases by 1°C; if the button is kept pressed, the setting temperature will increase quickly.

▼ Every time the button is pressed, the setting temperature decreases by 1°C, if the button is kept pressed, the setting temperature will decrease quickly.

Set the proper temperature.

(4) Adjust fan speed

Press FAN button. Each press, the fan speed changes as follows:

Code A



Air conditioner will run at the selected fan speed.

(5) Unit stop

Press ON/OFF button, the unit stops.

NOTE:

- In FAN mode, the temperature setting is not displayed on LCD.
- In DRY mode, when room temperature becomes 2°C higher than temperature setting, unit will run intermittently at LOW speed regardless of FAN setting. When room temperature is lower than temperature setting, unit will only run FAN operation.
- In HEAT mode, warm air will blow out after a short period of time due to cold-draft prevention function.

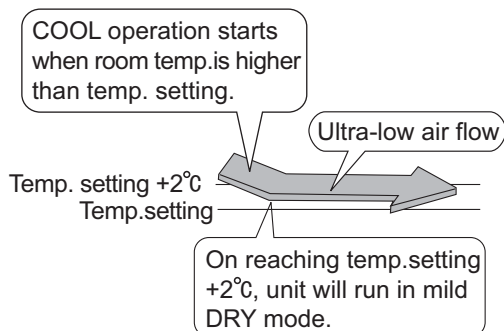

Operation instruction

Fan Operation (Only for Code A)

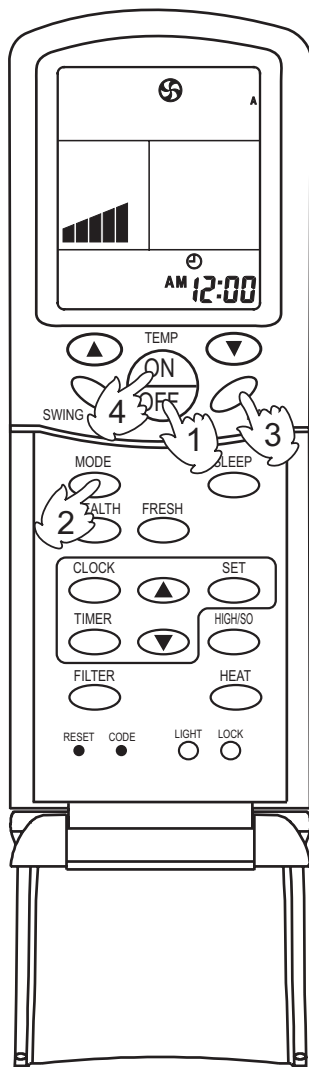

(1) Unit start

Press ON/OFF button to start your air conditioner. Previous operation status appears on LCD (except for TIMER, SLEEP, and SWING setting).

(2) Select operation mode

Press MODE button. Each press, the operation mode changes as follows:



Then select FAN mode.

(3) Adjust fan speed

Press FAN button. Each press, the fan speed changes as follows:



Air conditioner will run at the selected fan speed. When in AUTO mode, the unit will adjust fan speed according to room temperature automatically.

(4) Unit stop

Press ON/OFF button to stop unit.

About FAN mode

When the air conditioner runs in FAN mode, it is not possible to select AUTO FAN or to set temperature.

Buzzer

- In normal condition, use the wireless remote controller control the unit operation, unit received the signal and can operate according to its signal, the buzzer short ring one time , the operation is OK.
- When the unit meet the malfunction or indoor unit in abnormal conditions(different from outdoor working mode) ,use remote controller to control the function ,the buzzer short ring twice ,stands for the current operation can't be go through.
- The unit start with 26°C Lock functions ,when the cooling operation setting temp. lower than 26°C ,heating operation temp. higher than 20°C ,the buzzer long time ring one time ,stands for the setting temp. beyond the temp. range.
- When the buzzer working for Special functions ,the detailed functions see function explanation part.

Operation instruction

Adjusting Air Flow Directon

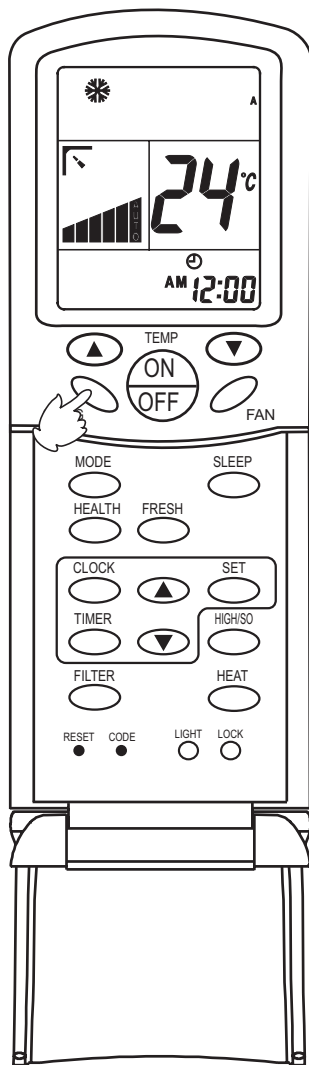

Adjusting air flow direction

Press SWING button.

Up and down airflow varies upwards and downwards.

Left and right airflow varies left and right sides.

When the automatic swing louver moves to the proper angle, press SWING button to fix the airflow direction.

After unit stops:

Displays on the LCD disappear.

All indicators on the indoor unit go out.

Swing louver automatically close the air outlet.

Warning

- Always use SWING button on the remote controller to adjust flaps. Adjusting them by hand may result in air conditioner's abnormally running. If the louver work abnormally, stop unit, restart and adjust the louver by remote controller.
- In COOL or DRY mode, do not leave the louver in downward position for a long time, as the water vapor close to the grille may condense and water may drop from the air conditioner.
- Please carefully set temperature when children, old or infirm people use the air conditioner.
- In case of great humidity, if the vertical flaps are completely turned towards left or right, the louver will drop water.

Hints:

- As in COOL mode air flows downwards, adjusting airflow horizontally will be much more helpful for a better air circulation
- As in HEAT mode air flows upwards, adjusting airflow downward will be much more helpful for a better air circulation.
- Be careful not to catch a cold when cold air blows downward directly.

Operation instruction

Timer ON/OFF Function

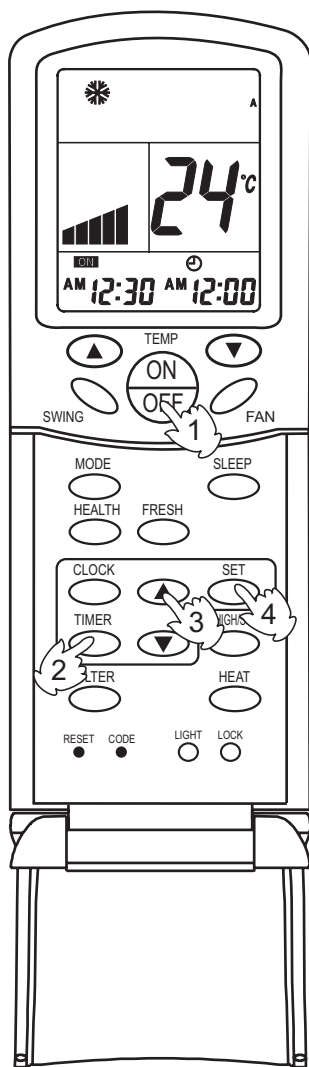

Set clock correctly before starting TIMER operation.

(1) Unit start

After unit start, select your desired operation mode (operation mode will be displayed on LCD).

(2) TIMER mode selection

Press TIMER button on the remote controller to change TIMER mode. Every time the button is pressed, display of TIMER mode changes as follows:



Then select TIMER mode as needed (TIMER ON or TIMER OFF). Now **ON** or **OFF** will flash.

(3) TIMER setting

Press time adjustment buttons \blacktriangle

- \blacktriangle Every time the button is pressed, the time increases by 10 minutes.
- \blacktriangledown Every time the button is pressed, the time decreases by 10 minutes.

If the button is kept pressed, the time will change quickly.

It can be adjusted within 24 hours at will.

(4) Confirm setting

After setting correct time, press SET button to confirm time. Now **ON** or **OFF** stop flashing.

Time displayed: unit starts or stops at X hour X min (TIMER ON or TIMER OFF)

(5) Cancel TIMER mode

Just press TIMER button several times until TIMER mode disappears.

Hints:

- After replacing batteries or if a power failure occurs, TIMER setting must be reset.
- Remote controller has memory function. When you use TIMER mode next time, just press SET button after mode selection if timer setting is the same as the previous one.

Operation hints

EMERGENCY OPERATION AND TEST OPERATION

EMERGENCY OPERATION

Carry out this operation only when the remote controller is defective or lost.

Unit start

When the emergency operation switch is pressed, a sound you can hear, which means the start of this operation.

Follow the requirements below.

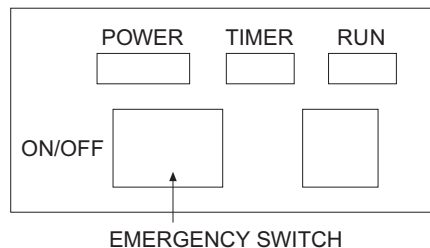

Room temperature	Designated temperature	Timer mode	Air flow speed	Operation mode	Anion
>23°C	26°C	None	AUTO	COOL	None
≤23°C	23°C	None	AUTO	HEAT	None

Unit stop (to cancel emergency operation)

Press the emergency switch and hear a sound, the unit stops.

TEST OPERATION

Use this switch in the test operation when the room temperature is less than 16 °C, do not use it in the normal operation.

Unit start

Continue to press the test operation switch for more than 5 seconds. After you hear the "BI" sound twice, release your finger from the switch, the test operation starts and the air conditioner starts with the air flow speed setting "HI".

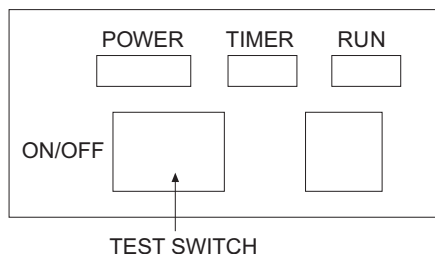

Unit stop (to cancel test operation)

Push the test run switch or operate with remote controller to cancel the test run.

If you use the remote controller to cancel the test run, the conditioner will then run as per the working mode displayed on the remote controller.

Power failure resume (please set and apply as necessary)

With setting of power failure resume, if sudden power failure occurs, the unit will resume original operation when power is supplied again.

Setting method:

with ON of remote controller (except TIMER and FAN), repeatedly press SLEEP button 10 times in 5 seconds, after 4 Beep from the buzzer, the unit comes into power failure resume mode.

To cancel:

press SLEEP button continuously 10 times in 5 seconds, the buzzer sounds Beep twice and power failure resume function is canceled.

Note:

When sudden power failure happens during unit operation in power failure resume mode, if the air conditioner is not desired for use in a long period, please shut off the power supply in case that the unit automatically resume operation when power is re-supplied, or press ON/OFF to turn off the unit when power resumes.

Operation hints

Special function

A. Emergency switch:

a) Press the emergency switch in stop condition, indoor unit operate with AUTO ,AUTO SPEED, 24°C Setting modes, pressure the emergency switch in start condition, indoor unit will stop operation.

b) Malfunction history list checking: in stopping condition, press the emergency with loose, 10 seconds later can hear the buzzer short ring 3 times and loose the button, indicator lamp flashing stands for error code, the remote controller signal or press emergency switch or 3 minutes later exit.

B. Unit number setting: can use SW2 set unit number, see SW2 sheets.

C. Temp. consumption:

Set the temp. consumption in Heating mode with remote controller, no temp. consumption in cooling mode. Press the sleeping button 8 times, the indoor unit buzzer will ring 5 times, the unit enter temp. consumption condition. Start the unit with remote controller, in heating mode, press temp. button ,select the setting temp..

Temp. consumption data=current temp.-24.For example, setting 24°C stands for Temp. consumption is 0°C ; setting 25°C, Temp. consumption data is 1°C ; setting 23°C, Temp. consumption data is -1°C. Press stop the unit button after finish the setting ,indoor unit buzzer will short ring 4 times, stands for exit temp. consumption setting.

D. Compulsive Defrost:

In heating mode, setting high speed ,set temp. is 30°C, press sleep button for 6 times, buzzer short ring 3 times, unit enter manual defrost mode..

E. Auto start function:

In on condition ,press the sleep button 10 times within 5 seconds, buzzer short ring 4 times stands for enter auto restart function; press the sleep button 10 times within 5 seconds, buzzer short ring 2 times stands for exit auto restart function .

The memory information: on/off condition, mode, fan speed, setting temp., swing position.

F. Single & double fan motor changeover:

Use remote controller setting single /double fan motor operation condition. In airflow mode, press the sleep button 6 times within 10 seconds, if the buzzer short ring twice stands for double fan motor condition; if only ring one time, stands for enter single fan motor mode.

G. Room card Function:

Room card function can realize by dip switch, pls. check the dip switch sheet.

a)Invalid: if dip switch selection is invalid ,both use remote controller and use room card start/stop the unit are OK. After connect to power supply, room card can't be valid until one open/close operation cycle .If Indoor unit in stop condition, room card close ,indoor unit operate according to AUTO,AUTO FAN Speed , 24°C setting and continuous swing modes. If indoor units in start condition ,room card closed, cancel the current timing function & modes setting temp. & fan speed don't changed.

b)Valid: If dip switch selection is valid, must make sure the room card close, then use remote controller control the operation, the indoor unit can operate(room card open or remote controller stop the unit, indoor units stop operation).

H. PMV manual control:

Short connect CN15 for 3 seconds, PMV fully open; re-short-connect CN15 for 3 seconds, PMV fully closed.

Maintenance

Cleaning of the unit

Turn off the power switch	Do not touch with wet hand	Do not clean with hot water or solvent
		

Take off the air inlet grill

First switch off the power supply, take off the screw cap, loosen the screw with cross screwdriver.

Clean the filter

Use water or vacuum cleaner to remove dust. If it is too dirt, clean with detergent or neutral soap water. Rinsing with fresh water, dry the filter and re-assemble.

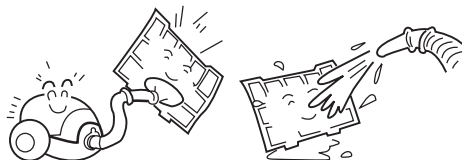

Caution:

Do not wash filter in hot water above 40°C, which will damage the filter. Do carefully wipe the filter.



Clean the indoor(outdoor) unit

Clean with warm cloth or neutral detergent, then wipe away moisture with dry cloth. Do not use too hot water (above 40°C), which will cause discoloration or deformation. Do not use pesticide or other chemical detergents.

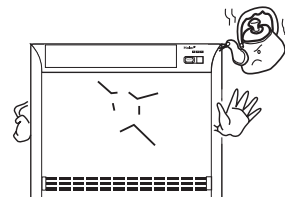

Maintenance at the end of application season

On a fine day, unit shall be started and operate in FAN mode for about half a day until the inside of the unit becomes thoroughly dry.

Turn off the unit operation switch and power on/off. Otherwise, there will be some electricity consumption even the unit is in stop status.

Clean the filter and indoor, cover the units well.

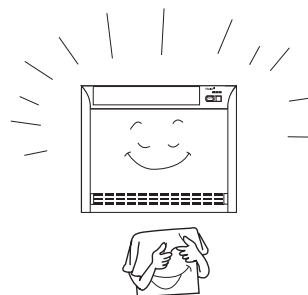



Maintenance before beginning of application season

Check there are no obstacles in the air inlet and outlet to avoid impairing of working efficiency.

Please do attach the air filter to ensure the electrostatic filters not soiled. Otherwise, dirt will come into and damage the unit or bring failures.

Fault Checkup

Before asking for service, check the following first.

	Phenomenon	Cause or check points
Normal Performance inspection	<p>The system does not restart immediately.</p> 	<ul style="list-style-type: none"> • When unit is stopped, it won't restart immediately until 3 minutes have elapsed to protect the system. • When the electric plug is pulled out and reinserted, the protection circuit will work for 3 minutes to protect the air conditioner.
	<p>Noise is heard:</p> 	<ul style="list-style-type: none"> • During unit operation or at stop, a swishing or gurgling noise may be heard. At first 2-3 minutes after unit start, this noise is more noticeable. (This noise is generated by refrigerant flowing in the system.) • During unit operation, a cracking noise may be heard. This noise is generated by the casing expanding or shrinking because of temperature changes. • Should there be a big noise from air flow in unit operation, air filter may be too dirty.
	<p>Smells are generated.</p>	<ul style="list-style-type: none"> • This is because the system circulates smells from the interior air such as the smell of furniture, cigarettes.
	<p>Mist or steam are blown out.</p>	<ul style="list-style-type: none"> • During COOL or DRY operation, indoor unit may blow out mist. This is due to the sudden cooling of indoor air.
Multiple check	<p>Does not work at all.</p>	<ul style="list-style-type: none"> • Is power plug inserted? • Is there a power failure? • Is fuse blown out?
	<p>Poor cooling</p> 	<ul style="list-style-type: none"> • Is the air filter dirty? Normally it should be cleaned every 15 days. • Are there any obstacles before inlet and outlet? • Is temperature set correctly? • Are there some doors or windows left open? • Is there any direct sunlight through the window during the cooling operation?(Use curtain) • Are there too much heat sources or too many people in the room during cooling operation?

Installation Procedures

Installation of indoor unit

Tool necessary

1. Screw driver
2. Hacksaw
3. 70mm dia.hole core drill
4. Spanner(dia. 17,27mm)
5. Spanner(14,17,27mm)
6. Pipe cutter
7. Flaring tool
8. Knife
9. Nipper
10. Gas leakage detector or soap water
11. Measuring tape
12. Reamer
13. Refrigerant oil

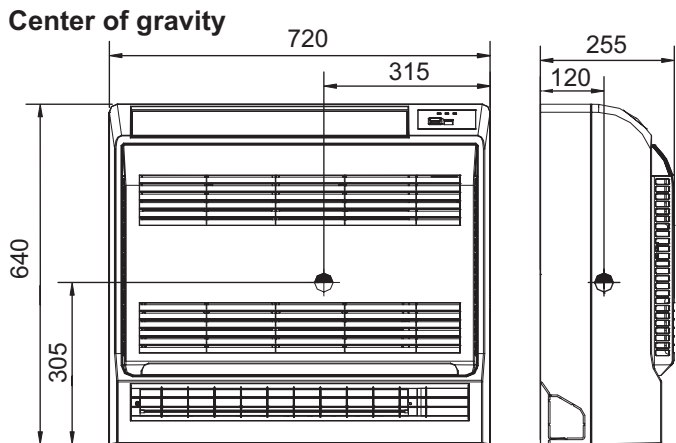

Selection of installation place

- Indoor unit must be used inside of room, not outdoor side, or some places with high humidity, like laundry.
- Place where it is easy to route drainage pipe and outdoor piping.
- Place, away from heat source and with less direct sunlight.
- Place where cool and warm air could be delivered evenly to every corner of the room.
- Place near power supply socket. Leave enough space around the unit.
- Place, robust not causing vibration, where the body can be supported sufficiently.
- To prevent interference, place it at least 1m away from other electric machines, such as TV set, radio.
- The A/C cannot be used for drying clothes. It cannot be covered with clothes.

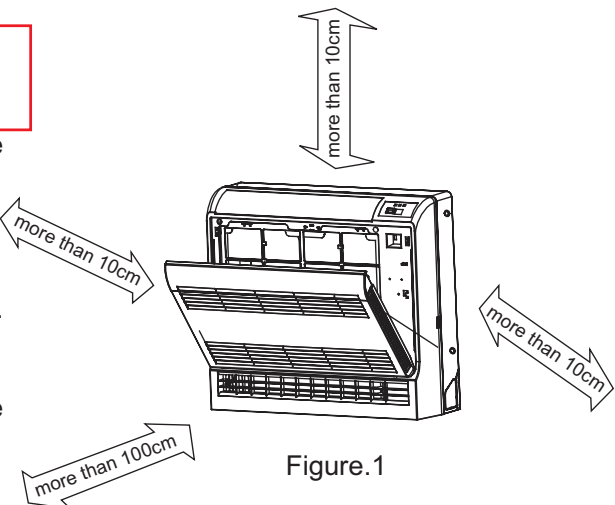

Figure.1

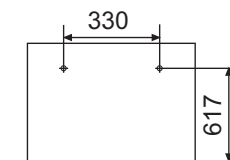

Figure.2

Installing

- According to the dimension of the figure 2 shown, nail two cement steel nails on the wall,Keep 2~3 mm out.then hang the back of the unit on them.
- There must be no gap between the indoor unit and wall.
- Remove the front panel,then use two fastening screws to fix the unit on the floor. As Figure 3 shown.
- Once refrigerant piping and drain piping connections are complete,fill the gap of the throught hole with putty.
- Attach the front panel and front grille in their original positions once all connections are complete.

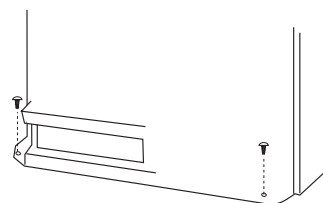

Figure.3

Installation Procedures

Fixing of the unit

1. Position of the wall hole

Wall hole should be decided according to installation place and piping direction.
(refer to installation drawings).

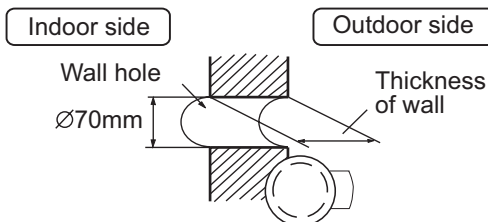

(Cross section of wall hole)

2. Making a wall hole

Drill a hole of 120X70mm dia. with a little slope towards outside.

Tubing Permissible Length & Height Difference

Please refer to the attached manual of outdoor units.

Tubing Materials & Specifications

Model		EAV012
Tubing Size (mm)	Gas pipe	∅12.7
	Liquid pipe	∅6.35
Tubing Material	Phosphor deoxybronze seamless pipe (TP2) for air conditioner	

Refrigerant Filling Amount

Add the refrigerant according to the installation instruction of outdoor unit. The addition of R410A refrigerant must be performed with a measure gage to ensure the specified amount while compressor failure can be caused by filling too much or little refrigerant.

Connecting Procedures of Refrigerant Tubing

• Schematic diagram for unit connection

Proceed the flare tube connecting operation to connect all the refrigerant tubes.

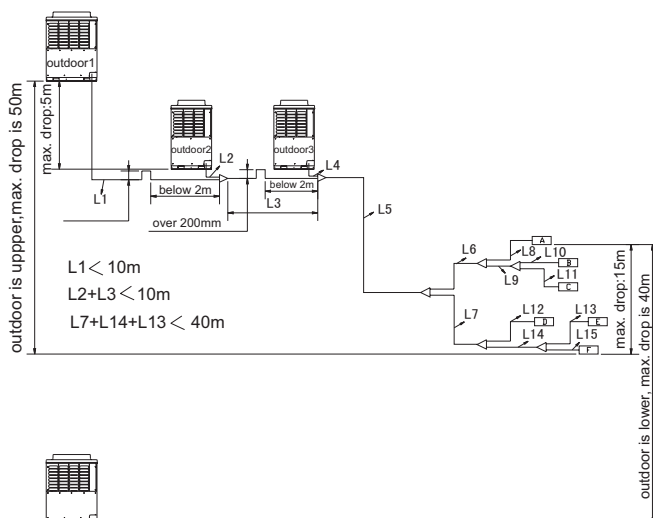

Installation Procedures

- Dual wrenches must be used in the connection of indoor unit tubing.
- Mounting torque refers to the right table
- Pipe connection process

Apply refrigeration oil on the end of the pipe to be connected and on the flared section. Align the pipes to be connected and tighten the nut. (See the figure)

Ensure that no foreign articles enter into the pipes.

Cautions for pipe connection

Pipes free from twists, deformation, water, dust.

Dedicated tools for each R407C and R410A should be used and stored separately.

Optimized radii of bends

Insulation to be applied on all gaseous pipes

Flared section free from cracks

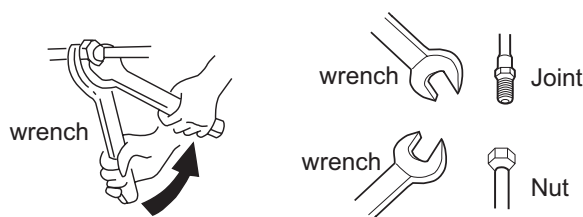

Threads on the pipes may be damaged when tightening if the pipes are not well aligned.

Outer Diameter of Tubing (mm)	Mounting Torque (N-m)	Increase mounting Torque (N-m)
Ø6.35	11.8(1.2kgf-m)	13.7(1.4kgf-m)
Ø12.7	49.0(5.0kgf-m)	53.9(5.5kgf-m)

Cutting and Enlarging

Cutting or enlarging pipes should be proceeded by installation personnel according to the operating criterion if the tube is too long or flare opening is broken.

Vacuumizing

Vacuumize from the stop valve of outdoor units with vacuum pump. Refrigerant sealed in indoor machine is not allowed to use for vacuumization.

Vacuum pump with check valve should be used for vacuumizing to prevent pump oil flowing into the machine.

Open All Valves

Open all the valves of outdoor units. [NB: oil balancing stop valve must be shut up completely when only connected one main unit.]

Checkup for Air Leakage

Check if there is any leakage at the connecting part and bonnet with hydrophone or soapsuds.

Connecting

1. Connecting circular terminals:

The connecting method of circular terminal is shown in the Fig. Take off the screw, connect it to the terminal tier after heading it through the ring at the end of the lead and then tighten it.

2. Connecting straight terminals:

The connection methods for the circular terminals are shown as follows: loosen the screw before putting the line terminal into the terminal tier, tighten the screw and confirm it has been clamped by pulling the line gently.

3. Pressing connecting line

After connecting line is completed, press the connecting line with clips which should press on the protective sleeve of the connecting line.

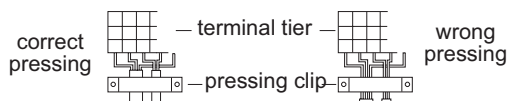

Electrical Wiring

⚠ Warning

- Electrical construction should be made with specific mains circuit by the qualified personnel according to the installation instruction. Electric shock and fire may be caused if the capacity of power supply is not sufficient. ⚠
- During arranging the wiring layout, specified cables should be used as the mains line, which accords with the local regulations on wiring. Connecting and fastening should be performed reliably to avoid the external force of cables from transmitting to the terminals. Improper connection or fastness may lead to burning or fire accidents. ⚠
- There must be the ground connection according to the criterion. Unreliable grounding may cause electrical shocks. Do not connect the grounding line to the gas pipe, water pipe, lightning rod and telephone line. ⚠

⚠ Attention

- Only copper wire can be used. Breaker for electric leakage should be provided, or electric shock may occur.
- The wiring of the mains line is of Y type. The power plug L should be connected to the live wire and plug N connected to null wire while ⊕ should be connected to the ground wire. For the type with auxiliary electrically heating function, the live wire and the null wire should not be misconnected, or the surface of electrical heating body will be electrified. If the power line is damaged, replace it by the professional personnel of the manufacturer or service center.
- The power line of indoor units should be arranged according to the installation instruction of indoor units.
- The electrical wiring should be out of contact with the high-temperature sections of tubing as to avoid melting the insulating layer of cables, which may cause accidents.
- After connected to the terminal tier, the tubing should be curved into be a U-type elbow and fastened with the pressing clip.
- Controller wiring and refrigerant tubing can be arranged and fixed together. ⚠
- The machine can't be powered on before electrical operation. Maintenance should be done while the power is shut down.
- Seal the thread hole with heat insulating materials to avoid condensation.
- Signal line and power line are separately independent, which can't share one line. [Note: the power line, signal line are provided by users. Parameters for power lines are shown as below: $3 \times (1.0-1.5) \text{ mm}^2$; parameters for signal line: $2 \times (0.75-1.25) \text{ mm}^2$ (shielded line)]
- 5 butt lines (1.5mm) are equipped in the machine before delivery, which are used in connection between the valve box and the electrical system of the machine. The detailed connection is displayed in the circuit diagram.

Supply Wiring Drawing

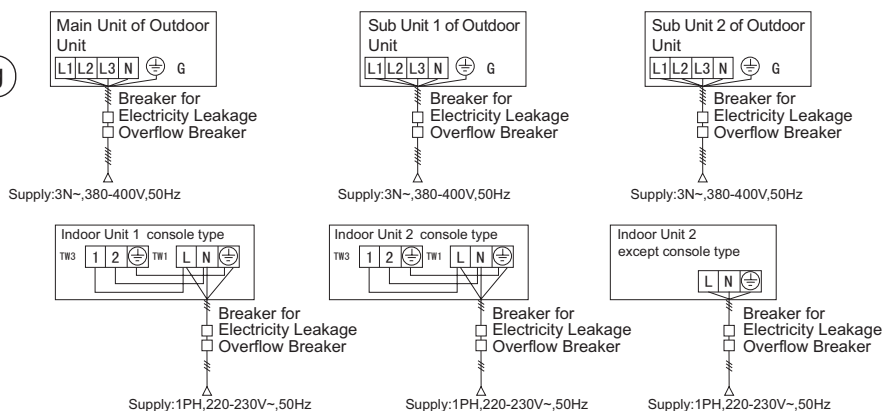

- Indoor units and outdoor units should be connected to the power source separately. Indoor units must share one single electrical source, but its capacity and specifications should be calculated. **Indoor & outdoor units should be equipped with the power leakage breaker and the overflow breaker.**
- An all-pole disconnection switch having a contact separation of at least 3mm in all poles should be connected in fixed wiring.

Electrical Wiring

Signal Wiring Drawing

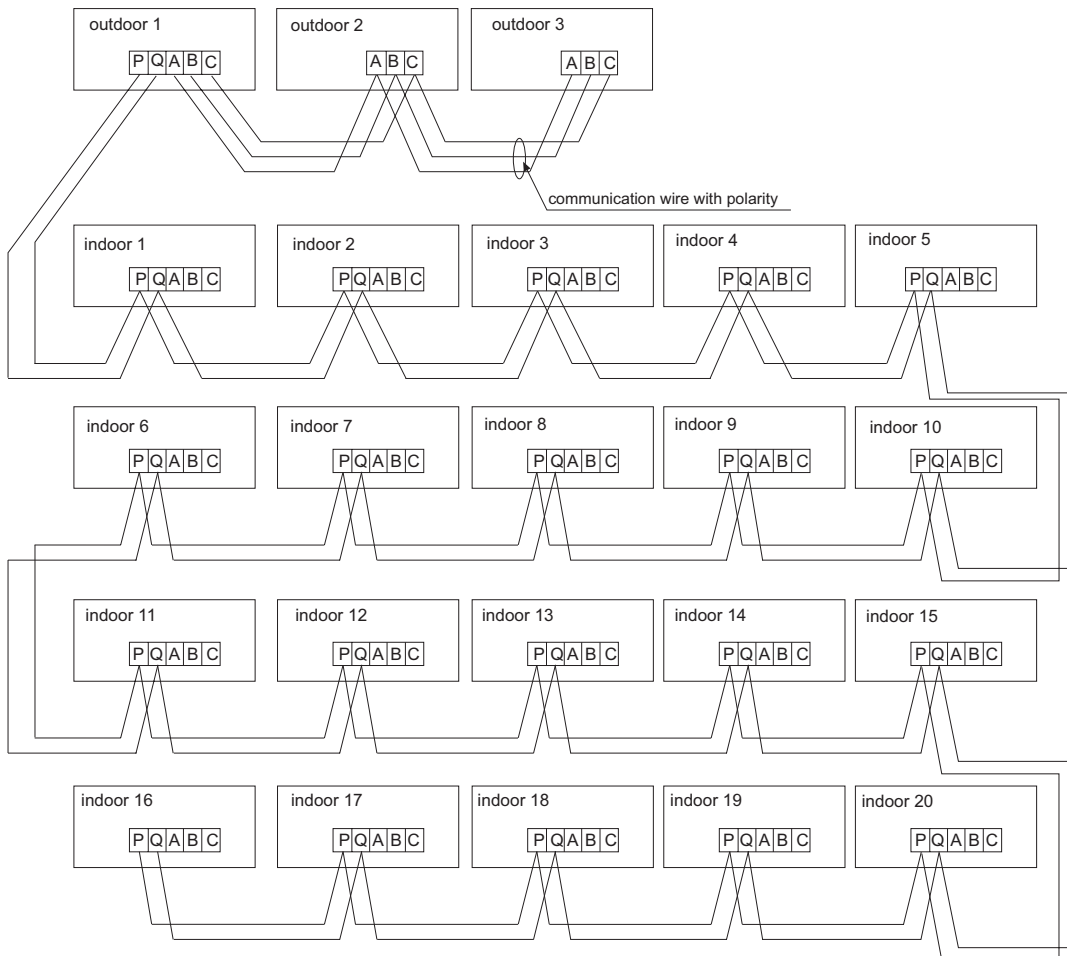

Outdoor units are of parallel connection via three lines with polarity. The main unit, central control and all indoor units are of parallel connection via two lines without polarity.

The wiring for the power line of indoor unit, the wiring between indoor and outdoor units as well as the wiring between indoor units:

Total Current of Indoor Units(A)	Items	Cross Section (mm ²)	Length (m)	Rated Current of Overflow Breaker(A)	Rated Current of Power Leakage Breaker (A) Leaking Current(mA) Operating Period (S)	Cross Sectional Area of Signal Line	
						Outdoor -indoor (mm ²)	Indoor -indoor (mm ²)
< 10		2	20	20	20 A, 30 mA, 0.1S or below	2 cores × 0.75-2.0 mm ² shielded line	
≥ 10 and < 15		3.5	25	30	30 A, 30 mA, 0.1S or below		
≥ 15 and < 22		5.5	30	40	40 A, 30 mA, 0.1S or below		
≥ 22 and < 27		10	40	50	50 A, 30 mA, 0.1S or below		

- ※ Power cable model: H05VV-F
- ※ The diameter of earth cable cannot be smaller than power cable's.
- ※ The electrical power line and signal lines must be fastened tightly.

Electrical Wiring

- ※ Every indoor unit must have the ground connection.
- ※ The power line should be enlarged if it exceeds the permissible length.
- ※ Shielded lays of all the indoor and outdoor units should be connected together, with the shielded lay at the side of signal lines of outdoor units grounded at one point.
- ※ It is not permissible if the whole length of signal line exceeds 1000m.

Code Setting

- ※ The code is dialed to “ON” position with the overline at the state of strapping if the code or overline status is “1”; The code is dialed to “OFF” position with the overline at the state of disconnection if the code or overline status is “0”.
- ※ In the table below, the choice in the box “□” refers to the setting of the socket/overline before delivery.

A. The central control address setting of indoor units: SW2

- ※ The setting of SW2 can be done by installation personnel during installation.

SW2								Switching Description
[1]	[2]	[3]	[4]	[5]	[6]	[7]	[8]	
--	0	0	0	0	0	0	0	Central control address = 1
--	0	0	0	0	0	0	1	Central control address = 2
----								----
--	1	1	1	1	1	1	0	Central control address = 127
--	1	1	1	1	1	1	1	Central control address = 128
1								Set the control address manually

B. Indoor units number and function setting: SW3

- ※ The setting of SW3 can be done by installation personnel during installation.

SW3								Switching Description
[1]	[2]	[3]	[4]	[5]	[6]	[7]	[8]	
--	--	0	0	0	0	0	0	Communication address of indoor units = 1
--	--	0	0	0	0	0	1	Communication address of indoor units = 2
----								----
--	--	1	1	1	1	1	0	Communication address of indoor units = 63
--	--	1	1	1	1	1	1	Communication address of indoor units = 64
1								Indoor address setting manual

C. Other function setting: SW1

SW1		Switching Description
[3]	[4]	
0	--	Room card invalid
1	--	Room card Valid
--	0	26°C lock function Invalid
--	1	26°C Lock function Valid

Test Run & Fault Code

Before Test Run

- Before switching it on, test the supply terminal tier (L, N terminals) and grounding points with 500V megaohm meter and check if the resistance is above 1M Ω . It can't be operated if it is below 1M Ω .
- Connect it to the power supply of outdoor units to energize the heating belt of the compressor. To protect the compressor at startup, power it on 12 hours prior to the operation.

Check if the arrangements of the drainpipe and connection line are correct.

The drainpipe shall be placed at the lower part while the connection line placed at the upper part. Heat preservation measures should be taken such as winding the drainpipe esp. in the indoor units with heating insulating materials.

The drain pipe should be made a slope type to avoid protruding at the upper part and concaving at the lower part on the way.

Checkup of Installation

- check if the mains voltage is matching
- check if there is air leakage at the piping joints
- check if the connections of mains power and indoor & outdoor units are correct
- check if the serial numbers of terminals are matching
- check if the installation place meets the requirement
- check if there is too much noise
- check if the connecting line is fastened
- check if the connectors for tubing are heat insulated
- check if the water is drained to the outside
- check if the indoor units are positioned

Ways of Test Run

Do ask the installation personnel to make a test run. Take the testing procedures according to the manual and check if the temperature regulator works properly.

When the machine fails to start due to the room temperature, the following procedures can be taken to do the compulsive running. The function is not provided for the type with remote control.

- Set the wired controller to refrigerating/heating mode, press "ON/OFF" button for 5 seconds to enter into the compulsive refrigerating/heating mode. Repress "ON/OFF" button to quit the compulsive running and stop the operation of the air conditioner.

Test Run & Fault Code

Malfunction code sheet

Malfunction	Flash times of timer lamp	Error code	Note
Fault of indoor unit ambient temp. transducer TA	1	1	Resumable
Fault of indoor unit pipe temp. transducer TC1	2	2	Resumable
Fault of indoor unit pipe temp. transducer TC2	3	3	Resumable
fault of underside fan door	4	4	Resumable
Fault of indoor unit EEPROM	5	5	Unresumable
Fault of communication between indoor & outdoor units	6	6	Alarm after continuous can't communicate with outdoor units for 3-minute, resumable
Fault of duplicate indoor unit address	9	9	Unresumable
Fault of duplicate central control address	10	10	Unresumable
fault of up fan motor	11	11	Indoor units add voltage, 10seconds later still can't find the fan motor pulse, close the indoor unit's voltage output, standby for 20 seconds, 10 seconds later, re add voltage, still no fan motor pulse, send out alarm signals.
fault of down fan motor	12	12	
Corresponding faults of outdoor units	20	20	Malfunction whether can be resumeable decided by Outdoor units;

Disposal

DISPOSAL:

Do not dispose this product as unsorted municipal waste. Collection of such waste separately for special treatment is necessary.

It is prohibited to dispose of this appliance in domestic household waste.

For disposal there are several possibilities:

- a) The municipality has established collection systems, where electronic waste can be disposed of at least free of charge to the user.
- b) When buying a new product, the retailer will take back the old product at least free of charge.
- c) The manufacturer will take back the old appliance for disposal at least free of charge to user.
- d) As old products contain valuable resources, they can be sold to scrap metal dealers.

Wild disposal of waste in forests and landscapes endangers your health when hazardous substances leak into the ground-water and find their way into the food chain.

Airwell France SAS, 1 bis rue du 8 mai 1945 - 78 280 Guyancourt, France